

use & care guide

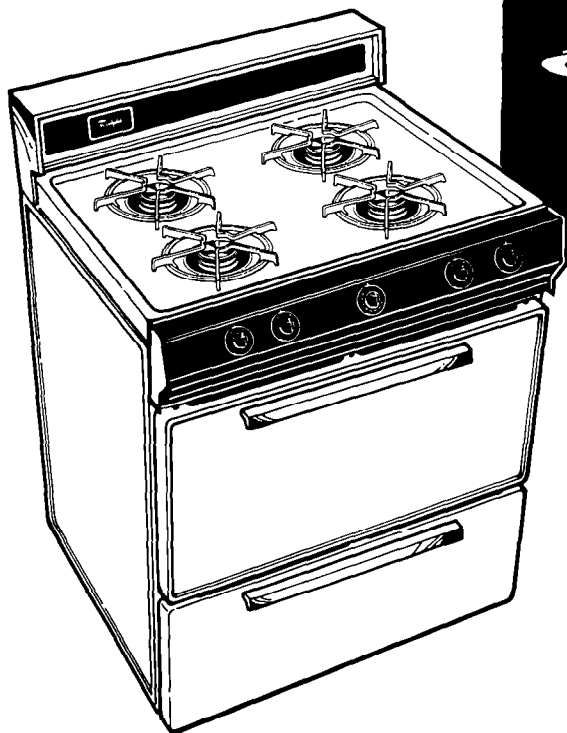

The Whirlpool logo, consisting of a stylized swirl above the word "Whirlpool" in a serif font.

**GAS
RANGE**

Model SF3004SR

Microwave Ovens, Trash Compactors, Room Air Conditioners, Dehumidifiers, Automatic Washers, Clothes Dryers, Freezers, Refrigerator-Freezers

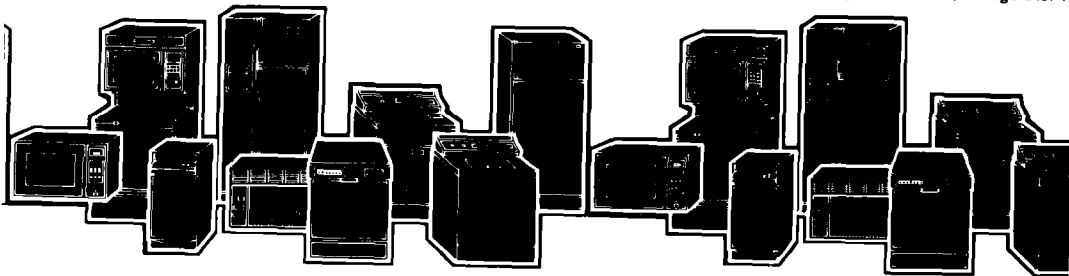

Contents

	Page		Page
BEFORE YOU USE YOUR RANGE	2	Control Panel	10
IMPORTANT SAFETY INSTRUCTIONS	3	Surface Burner Grates	11
PARTS AND FEATURES	5	Lift-Up Cooktop	11
USING YOUR RANGE	6	Surface Burners	12
Using the Surface Burners ..	6	Oven Door	12
Using the Oven Control	7	Standard Oven Cleaning ..	12
Baking	7	Cleaning Chart	13
Broiling	8	IF YOU NEED SERVICE OR ASSISTANCE	14
Oven Vent	9	WHIRLPOOL RANGE WARRANTY	16
CARING FOR YOUR RANGE ..	10		

©1987 Whirlpool Corporation

Before you use your range

Read and carefully follow the "INSTALLATION INSTRUCTIONS" packed with your range.

Read this Use & Care Guide and the Cooking Guide for important safety information.

• FOR YOUR SAFETY •
TO PREVENT FIRE AND EXPLOSION, DO NOT STORE OR USE GASOLINE OR OTHER FLAMMABLE VAPORS AND LIQUIDS IN THE VICINITY OF THIS OR ANY OTHER APPLIANCE.

• FOR YOUR SAFETY •
IF YOU SMELL GAS:
1. OPEN WINDOWS.
2. DON'T TOUCH ELECTRICAL SWITCHES.
3. EXTINGUISH ANY OPEN FLAMES.
4. IMMEDIATELY CALL YOUR GAS SUPPLIER.

• FOR YOUR SAFETY •
DO NOT OBSTRUCT THE FLOW OF COMBUSTION AND VENTILATION AIR.

You are personally responsible for:

- Reading and following all safety precautions in this Use & Care Guide and the Cooking Guide.
- Having your range installed by a qualified installer.
- Installing the range where it is protected from the elements, and on a level floor strong enough to hold its weight.
- Having your range properly connected to the proper gas supply and checked for leaks. (See "Installation Instructions.")
- Making sure the range is not used by children or anyone unable to operate it properly.
- Properly maintaining your range.
- Using the range only for jobs expected of a home range.

See "Cooking Guide" for important safety and use information.

IMPORTANT SAFETY INSTRUCTIONS



WARNING – When using your range, follow basic precautions, including the following:

- 1. DO NOT** allow children to use or play with any part of the range, or leave them unattended near it. They could be burned or injured.
- 2. DO NOT** store things children might want above the range. Children could be burned or injured while climbing on it.
- 3. DO NOT** allow anyone to touch a hot surface burner, oven burner or areas around them. They could be hot enough to burn severely.
- 4. KEEP** children away from the range when it is on. The cooktop, oven walls, racks and door can be hot enough to cause burns.
- 5. DO NOT** use a range to heat a room. Persons in the room could be burned or injured, or a fire could start.
- 6. KEEP** pan handles turned in, but not over another surface burner to prevent burns, injury and to help prevent the utensil from being pushed off the cooktop.
- 7. DO NOT** use water on grease fires. The fire will spread. Cover fire with large lid or smother with baking soda or salt.
- 8. DO NOT** wear loose or hanging garments when using the range. Garments could ignite if they touch a hot burner or surrounding area and you could be burned.
- 9. DO NOT** heat unopened containers. They could explode. The hot contents could burn and container particles could cause injury.
- 10.** When adding or removing food, **MAKE SURE** to open the oven door all the way to prevent burns.

continued on next page

- 11. DO NOT** use a wet pot holder. Steam burns can result. **DO NOT** use a towel or bulky cloth as a pot holder. They could catch fire and burn you.
- 12. MAKE SURE** the utensils you use are large enough to contain food and avoid boil-overs and spill-overs. This will help prevent hazardous build-ups of food. Heavy splattering or spill-overs left on a range can ignite and burn you. Pan size is especially important in deep fat frying.
- 13. DO NOT** leave surface burners on high heat settings. Boil-overs and greasy spillovers could cause steam, smoke and could ignite and burn you.
- 14. GREASE** is flammable and should be handled carefully. Let fat cool before attempting to handle it. **Do not allow grease to collect around range or in vents.** Wipe spill-overs immediately.
- 15. NEVER** use a match or other flame to look for a gas leak. Explosion and injury could result.
- 16. DO NOT** repair or replace any parts unless specifically recommended in this manual. All other servicing should be referred to a qualified service technician.
- 17. DO NOT** use oven for storage. Stored items and range could be damaged if oven is turned on accidentally.

• **FOR YOUR SAFETY** •

DO NOT STORE OR USE GASOLINE OR OTHER FLAMMABLE VAPORS AND LIQUIDS IN THE VICINITY OF THIS OR ANY OTHER APPLIANCE. THEY COULD IGNITE CAUSING EXPLOSION AND/OR FIRE.

– SAVE THESE INSTRUCTIONS –

Copy your Model and Serial Numbers here...

If you need service, or call with a question, have this information ready:

- 1. Complete Model and Serial Numbers** (from the plate located as shown).
 - 2. Purchase date** from sales slip.
- Copy this information in these spaces. Keep this book and your sales slip together in the Literature Pac.

Model Number

Serial Number

Purchase Date

Service Company Phone Number

Please complete and mail the Owner Registration Card furnished with this product.

Parts and features

Models SF3004SR

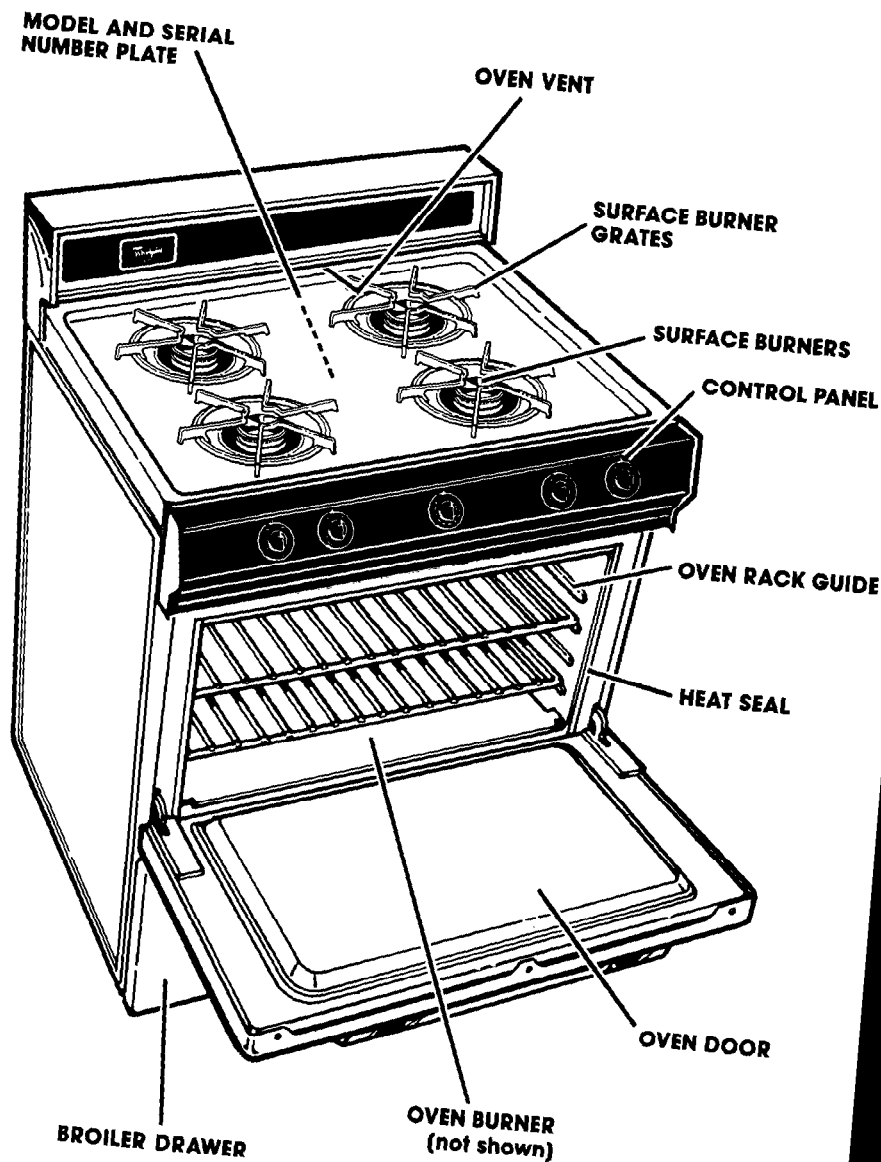

SAFETY • PARTS AND FEATURES

Using your range

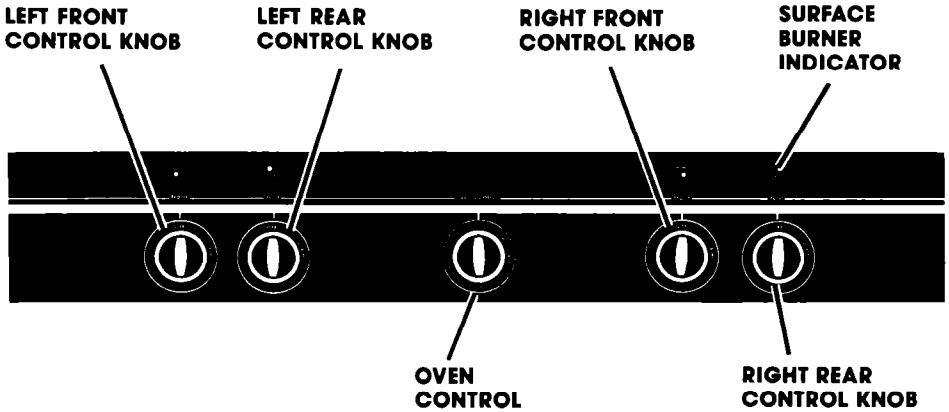

Using the Surface Burners

This range is equipped with standing pilots. Standing pilots must be lit initially with a match following the directions on page 9. The pilot light will remain lit when the burners are turned off. To turn a burner on again, just push in and turn the control knob to LITE and the burner will light.

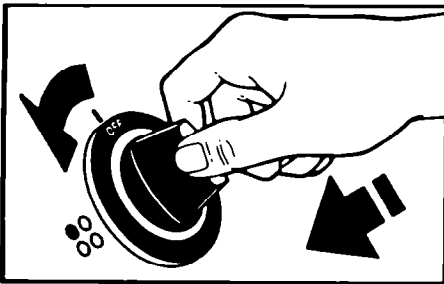

Control knobs must be pushed in, then turned to LITE position.

After the burner lights, turn the control knob back to a desired setting. The control knob can be set anywhere between HI and a low setting. **Do not cook with the control in the LITE position.**

Surface Burner Indicators

The solid dot in the surface burner indicator shows which surface burner is turned on by that knob.



WARNING: If the flame should go out while cooking, or if there is a strong gas odor, turn the burners OFF. Wait five minutes for the gas odor to disappear before relighting burner. IF GAS ODOR IS STILL PRESENT, SEE SAFETY NOTE ON PAGE 2.



WARNING: Burner flame should not extend beyond the edge of the cooking utensil. The flame can burn you and cause poor cooking results.

See the "Cooking Guide" for Important utensil information. Until you get used to the settings, use the following as a guide.

Use **LITE** to light the burner. After the burner lights, turn control back to a desired setting.

Do not cook with the control in the LITE position.

Use a **high setting** to start cooking or to bring liquids to a boil.

Use a **medium setting** to start cooking or to fry chicken or pancakes; for gravy, puddings and icing or to cook large amounts of vegetables.

Use a **low setting** to keep foods warm until ready to serve.

Using the Oven Control

Baking

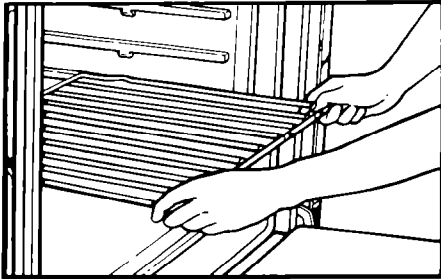

1. Position the racks properly **before** turning on the oven. **To change rack position**, pull rack out to stop, raise front edge and lift out.

Racks should be placed so the top of the food will be centered in the oven. Always leave at least 1½ to 2 inches (4-5 cm) between the sides of the pan and the oven walls and other pans. For more information, see the "Cooking Guide."

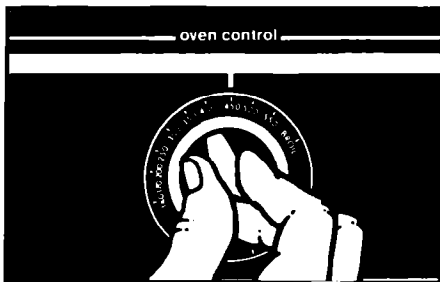

2. Set the Oven Control to the baking temperature you want. The oven burner will automatically light in 50-60 seconds.

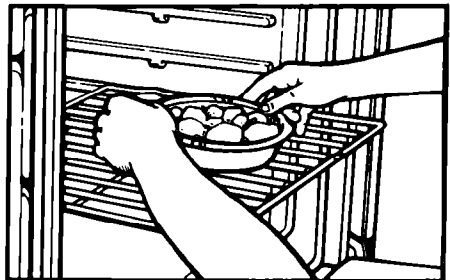

3. Preheat the oven for 10 minutes before adding food. **NOTE: Oven racks, walls and door will be hot. Do not place food directly on oven bottom.**

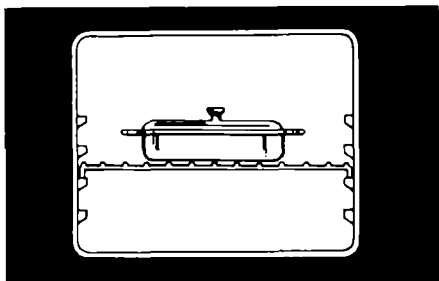

4. During baking, the oven burner will turn on and off to maintain the temperature setting.

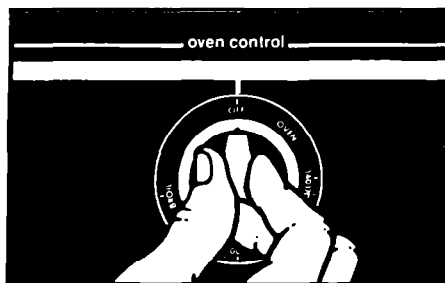

5. When baking is done, turn the Oven Control to OFF.

Broiling

The Broiler Drawer is located below the oven door. **Always broil with the drawer and oven door completely closed.**

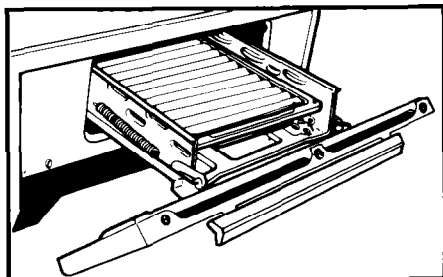

1. Pull the broiler drawer open and tilt the door panel down.

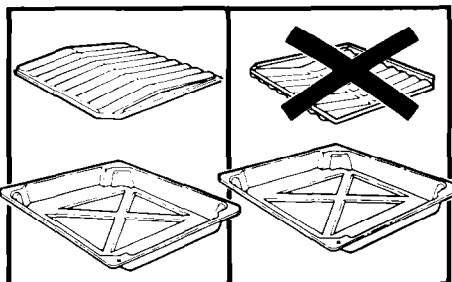

2. Place broiler pan grid so grease can drain down sides into lower part of broiler pan. See picture.

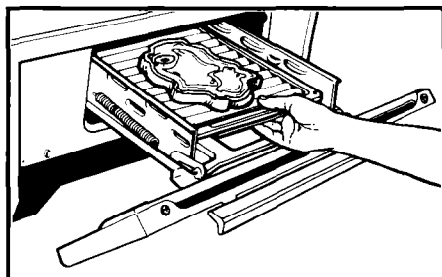

3. Place food on broiler pan and position the broiler pan **before** turning on the broiler. See pan placement chart in the "Cooking Guide" for recommended pan positions.

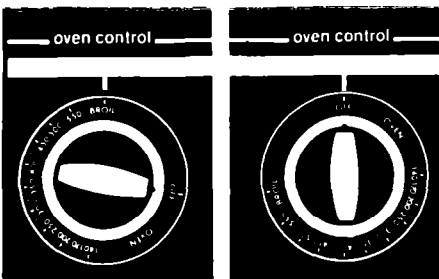

4. Set the Oven Control to BROIL. The broiler will automatically light in 50-60 seconds.

5. When broiling is done, turn the Oven Control to OFF.

DO NOT PREHEAT THE BROILER BEFORE USING. COMPLETELY CLOSE THE BROILER DRAWER DURING BROILING.

The Oven Vent

Hot air and moisture escape from the oven through a vent located under the backguard. **Do not block vent.** Poor baking will result.

OVEN VENT

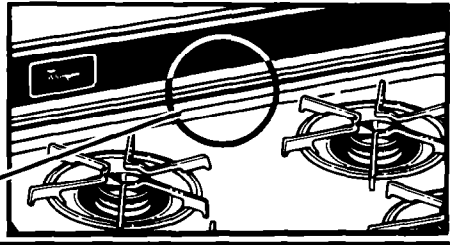

Lighting Standing Pilots

To Light Cooktop Pilots:

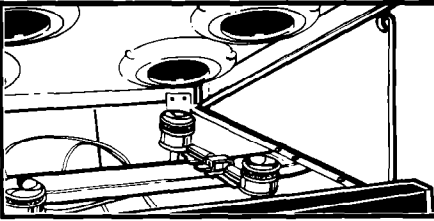

1. Remove the surface burner grates from the cooktop. Lift the cooktop and rest on support rod.
2. Make sure all controls are OFF.

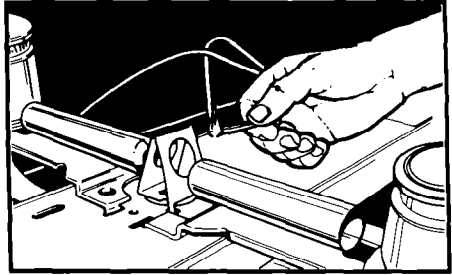

3. **To light**, hold a lit match over the pilot light located between the front and back burners. The pilot flame should be $\frac{1}{4}$ to $\frac{3}{8}$ in (.635-.953 cm) high.
4. If the pilot flame needs adjustment, turn the pilot adjustment screw on the manifold pipe.
5. Lower the cooktop and replace the grates before using the surface burners.

To Light Oven Burner Pilot:

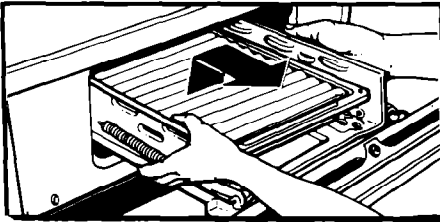

1. Make sure the oven control is OFF.
2. Remove the broiler drawer. Slide drawer out to stops, lift both sides, then slide the rest of the way out.

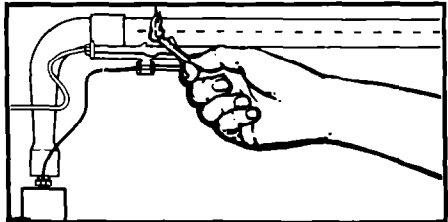

3. Hold a lit match over the oven burner pilot located at the rear of the burner.
4. After the oven burner pilot is burning steady, check burner lighting by turning the Oven Control to a temperature above 140°F (60°C). The burner will take 50-60 seconds to light.
5. Replace the broiler drawer.

Caring for your range

Control Panel



WARNING: To avoid burns, first make sure all controls are off and the range is **COOL**.

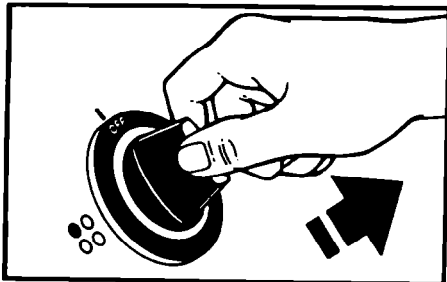

1. Pull knobs straight off.

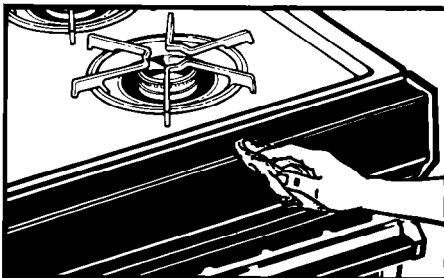

2. Use warm soapy water, baking soda and a damp soft cloth or spray glass cleaner to wipe the control panel. Rinse and wipe dry.

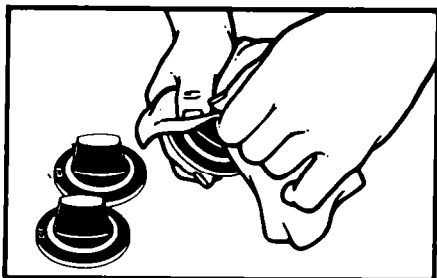

3. Wash knobs in warm soapy water or use baking soda and a damp, soft cloth or follow directions provided with glass cleaner. Rinse well and dry.

CAUTION: Do not soak or use abrasive cleansers. They could rub off the markings.

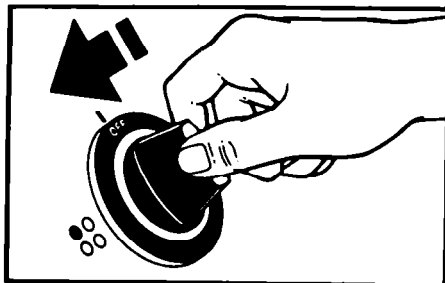

4. Push the knobs straight back on. Make sure they point to OFF.

Surface Burner Grates

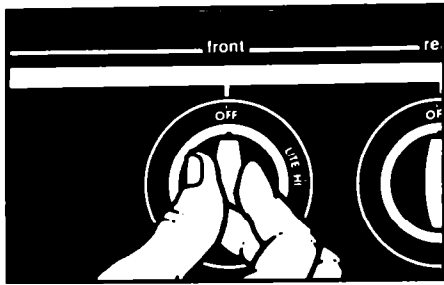

1.  **WARNING:** To avoid burns, be sure the surface burners are **OFF** and the surrounding parts are **COOL**.

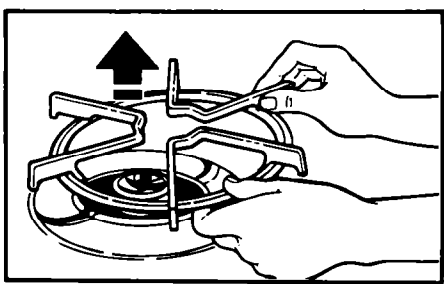

2. Lift off the surface burner grates.

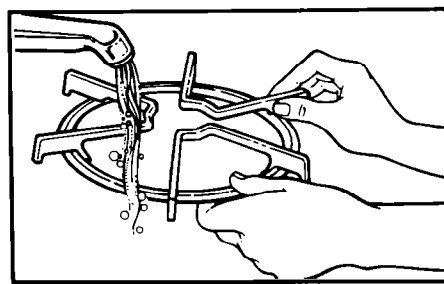

3. Wash the grates in automatic dishwasher or use warm soapy water and plastic scrub pad. Rinse and dry well.

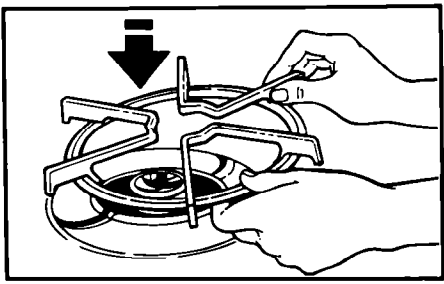

4. Replace the surface burner grates.

Lift-Up Cooktop

1. Lift front of cooktop at corners and swing up the support rod.
2. Carefully lower the cooktop onto the support rod.

 **WARNING:** Be sure the rod fits in the notch in the cooktop and is held securely. The cooktop could accidentally fall and injure you.

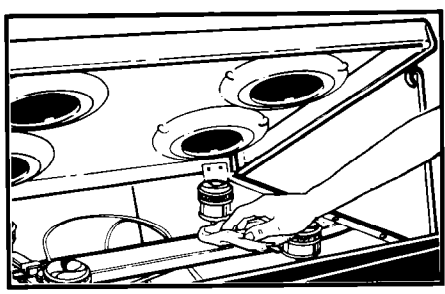

CAUTION: Do not drop the cooktop. Damage can result to the porcelain and the cooktop frame.

3. Wipe surface under cooktop with warm soapy water. Use soapy plastic scrub pad on stubborn spots.

Surface Burners

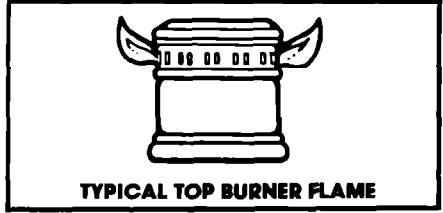
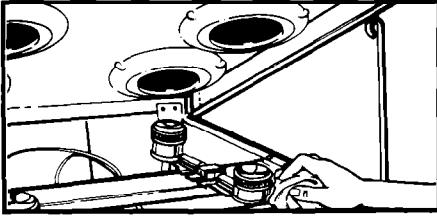

Lift up the cooktop, following the instructions on page 12.

Wipe off surface burners with warm soapy water and a soft cloth after each use.

Occasionally check surface burner flames for size and shape as shown. If flames do not burn properly, you may need to remove the surface burners for cleaning (see page 13), or call a qualified technician for burner adjustments.

The Oven Door

Removing the oven door will make it easier to clean the oven.

-  **WARNING: To avoid burns, be sure the oven is OFF and COOL.**

Open the door to the first stop position.

- Hold the door at both sides and lift off of hinges at bottom corners of door.
- To replace**, fit the bottom corners of the door over the ends of the hinges.

Push the door down evenly. The door will close only when it is on the hinges correctly.

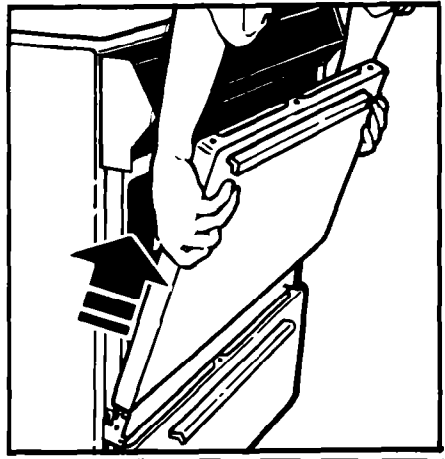

Standard Oven Cleaning

The Standard Oven has to be hand cleaned. Use warm soapy water and steel wool pads and a commercial oven cleaner. See "Cleaning Chart" for further instructions.

Do not allow commercial oven cleaner to contact the oven seals, thermostat or exterior surfaces of the range. Damage will occur.

Using Foil

To catch sugar or starchy spills from pies and casseroles, use a piece of heavy-duty aluminum foil or a shallow pan on the lower rack, slightly larger than the cooking container.

CAUTION: Do not use foil to cover oven floor or to completely cover a rack. Good air circulation is needed for the oven to operate properly. Poor cooking results and damage to the oven could occur.

Cleaning Chart



WARNING: To avoid burns, be sure all controls are OFF and the range is COOL.

PART	WHAT TO USE	HOW TO CLEAN
Exterior surfaces	Soft cloth and warm soapy water or baking soda. Nylon or plastic scrubbing pad for stubborn spots.	<ul style="list-style-type: none"> • Wipe off regularly when cooktop and range are cool. • Do not allow food containing acids (such as vinegar, tomato, lemon juice or milk) to remain on surface. Acids will remove the finish. • Do not use abrasive or harsh cleansers.
Surface burner grates	Automatic dishwasher or warm soapy water and plastic scrubbing pad.	<ul style="list-style-type: none"> • Wash with other cooking utensils. • Dry completely. • Do not use abrasive or harsh cleansers.
Surface burners	Warm soapy water, a plastic scrubbing pad, dishwashing detergent or a solution of 1 quart of boiling hot water and 2 tablespoons of DIP IT®	<ul style="list-style-type: none"> • Lift-up the cooktop, see page 11. • Wipe off spills immediately after burner has cooled. In case of stubborn stains: • Remove burner from manifold with phillips screwdriver. • Soak in warm soapy water and wipe with plastic scrubbing pad and dishwashing detergent. If stain is still there, soak 20 minutes in boiling water and DIP IT® solution. Be sure the solution covers the whole burner. • Rinse and dry well. • If ports are clogged, clean with a straight pin. Do not enlarge or distort ports. Do not use a wooden toothpick. • Do not clean surface burner in dishwasher.
Broiler drawer, pan and grid	Warm soapy water and plastic scrubbing pad.	<ul style="list-style-type: none"> • Clean after each use. • Wash pan and grid with other utensils. • After broiler is cool, wipe interior with warm damp cloth. For stubborn spots, use a plastic scrubbing pad.
Control knobs	Warm soapy water and soft cloth.	<ul style="list-style-type: none"> • Wash, rinse and dry well. • Do not soak.

continued on next page

PART	WHAT TO USE	HOW TO CLEAN
Control panels	Warm soapy water or baking soda, soft cloth and spray glass cleaner.	<ul style="list-style-type: none"> • Wash, rinse and dry well. • Follow directions provided with cleaner.
Oven racks	Warm soapy water and plastic scrubbing pad.	<ul style="list-style-type: none"> • Wash, rinse and dry well. Use plastic scrubbing pad for stubborn areas.
Standard oven	Warm soapy water or soapy steel wool pad. Commercial oven cleaners.	<ul style="list-style-type: none"> • Remove door for easier access. • Place newspaper on floor to protect floor surface. • Follow directions provided with the oven cleaner. • Rinse well with clear water. • Use in well ventilated room. • Do not allow commercial oven cleaner to contact the oven seals, thermostat or exterior surfaces of the range. Damage will occur.

If you need service or assistance, we suggest you follow these five steps:

1. Before calling for assistance...

Performance problems often result from little things you can find and fix without tools of any kind.

If nothing operates:

- Is the range properly connected to the gas supply? (See "Installation Instructions.")
- Is the flow of combustion and/or ventilation air to the range blocked? **Do not block the air flow to and around the range.**
- Is the Oven Control turned to a temperature setting or BROIL?

If burner falls to light:

- Is the range connected to the gas supply?
- Are burner ports clogged? (See page 13.)

If burner flames are uneven:

- Are burner ports clogged? (See page 13.)

If control knob(s) will not turn:

- Did you push in before trying to turn?

If burner flames lift off ports, are yellow, or are noisy when turned off:

- The air/gas mixture may be incorrect. (Call for service.)

If burner makes a popping noise when ON:

- Is the burner wet from washing? Let dry.

If cooking results aren't what you expected:

- Is the range level?
- Are you using pans recommended in the "Cooking Guide"?
- If baking, have you allowed 1½ to 2 inches (4-5 cm) on all sides of the pans for air circulation?
- Have you preheated the oven as the recipe calls for?
- Are the pans the size called for in the recipe?
- Are you following a tested recipe from a reliable source?
- Do the cooking utensils have smooth, flat bottoms and fit the surface burners?

See the **Cooking Guide** for more information on cooking problems and how to solve them.

2. If you need assistance*...

Call Whirlpool COOL-LINE® service assistance telephone number. Dial free from anywhere in the U.S.:
1-800-253-1301

and talk with one of our trained Consultants. The Consultants can instruct you in how to obtain satisfactory operation from your appliance or, if service is necessary, recommend a qualified service company in your area.

3. If you need service*...



Whirlpool has a nationwide network of franchised TECH-CARE® Service Companies.

TECH-CARE service technicians are trained to fulfill the product warranty and provide after-warranty service, anywhere in the United States. To locate TECH-CARE service in your area, call our COOL-LINE service assistance telephone number (see Step 2) or look in your telephone directory Yellow Pages under:

APPLIANCES - HOUSEHOLD -
 MAJOR - SERVICE & REPAIR

WHIRLPOOL APPLIANCES
 FRANCHISED TECH-CARE SERVICE

SERVICE COMPANIES
 XYZ SERVICE CO
 123 MAPLE

999-9999

ELECTRICAL APPLIANCES -
 MAJOR - REPAIRING & PARTS

OR

WHIRLPOOL APPLIANCES
 FRANCHISED TECH-CARE SERVICE

SERVICE COMPANIES
 XYZ SERVICE CO
 123 MAPLE

999-9999

OR

WASHING MACHINES, DRYERS
 & IRONERS - SERVICING

WHIRLPOOL APPLIANCES
 FRANCHISED TECH-CARE SERVICE

SERVICE COMPANIES
 XYZ SERVICE CO
 123 MAPLE

999-9999

4. If you have a problem*...

Call our COOL-LINE service assistance telephone number (see Step 2) and talk with one of our Consultants, or if you prefer, write to:

Mr. Robert Stanley
 Division Vice President
 Whirlpool Corporation
 2000 US-33, North
 Benton Harbor, MI 49022

5. If you need FSP® replacement parts*...

FSP is a registered trademark of Whirlpool Corporation for quality parts. Look for this symbol of quality whenever you need a replacement part for your Whirlpool appliance. FSP replacement parts will fit right and work right, because they are made to the same exacting specifications used to build every new Whirlpool appliance.

To locate FSP replacement parts in your area, refer to Step 3 above or call the Whirlpool COOL-LINE service assistance number in Step 2.

*If you must call or write, please provide: model number, serial number, date of purchase, and a complete description of the problem. This information is needed in order to better respond to your request for assistance.

WHIRLPOOL MICROWAVE OVEN/ RANGE PRODUCT WARRANTY

LENGTH OF WARRANTY	WHIRLPOOL WILL PAY FOR
FULL ONE-YEAR WARRANTY From Date of Purchase	Replacement parts and repair labor to correct defects in materials or workmanship. Service must be provided by a franchised TECH-CARE® service company.
LIMITED FOUR-YEAR WARRANTY Second Through Fifth Year From Date of Purchase	Replacement magnetron tube on microwave ovens if defective in materials or workmanship.
WHIRLPOOL WILL NOT PAY FOR	
<p>A. Service calls to:</p> <ol style="list-style-type: none"> 1. Correct the installation of the range product. 2. Instruct you how to use the range product. 3. Replace house fuses or correct house wiring or plumbing. 4. Replace owner accessible light bulbs. <p>B. Repairs when range product is used in other than normal, single-family household use.</p> <p>C. Pick up and deliver. This product is designed to be repaired in the home.</p> <p>D. Damage to range product caused by accident, misuse, fire, flood, acts of God or use of products not approved by Whirlpool.</p> <p>E. Any labor costs during the limited warranty.</p>	

WHIRLPOOL CORPORATION SHALL NOT BE LIABLE FOR INCIDENTAL OR CONSEQUENTIAL DAMAGES. Some states do not allow the exclusion or limitation of incidental or consequential damages so this limitation or exclusion may not apply to you. This warranty gives you specific legal rights, and you may also have other rights which vary from state to state.

Outside the United States, a different warranty may apply. For details, please contact your franchised Whirlpool distributor or military exchange.



Part No. 75592-00/786763 Rev. B
©1987 Whirlpool Corporation

Printed in U.S.A.

Automatic Washers, Clothes Dryers, Freezers, Refrigerator-Freezers, Ice Makers, Dishwashers, Built-In Ovens and Surface Units, Ranges

